

P1P Short Build Compact Cylinders

According to ISO 21287



The P1P Series is a complete range of ISO 21287 compact cylinders developed to meet the highest requirements for quality and performance. The careful design in every detail provides first class function and service life properties.

Reliability and long service life are key qualities of any pneumatic cylinder. Therefore we have given P1P highest possible quality in every detail based on our 40 years of experience and extensive testing. The design is based on the following important principles.

- **Proven seal design and materials throughout the cylinder. The expertise for seal technology within Parker Hannifin is the basis for leading and proven tribology solutions for all our pneumatic actuators.**
- **Body extrusion in anodised aluminium with extra fine and hard internal surface for optimum operational conditions.**
- **End covers and body extrusion with external anodisation for excellent corrosion resistance.**
- **Stainless steel piston rod for versatile use in corrosive environment.**



Double acting

The versatile high quality ISO compact cylinder range, P1P cylinders are up to 50% shorter than ISO15552 cylinders for the same stroke. Suitable for a wide range of applications.

- Bore 20 - 100 mm
- ISO 21287 conformity
- Corrosion resistant design and low weight construction
- Magnetic piston as standard
- Elastic cushioning
- Flexible direct mounting
- ISO 15552 mountings and global sensor range common with P1D



Operating information

Working pressure: Max 10 bar
Permissible fluid: Air, with or without lubrication

Seals / Temperature options

Standard: -20°C to +80°C
High temperature: -10°C to +120°C
Low temperature: -40°C to +80°C

Prelubricated, further lubrication is not normally necessary. If additional lubrication is introduced it must be continued.

For more information see www.parker.com/euro_pneumatic

Double acting - Female threaded piston rod

Ø20mm - (M5)

Stroke mm	Order code
5	P1PS020DS7G0005
10	P1PS020DS7G0010
15	P1PS020DS7G0015
20	P1PS020DS7G0020
25	P1PS020DS7G0025
30	P1PS020DS7G0030
40	P1PS020DS7G0040
50	P1PS020DS7G0050
60	P1PS020DS7G0060

Ø25mm - (M5)

Stroke mm	Order code
5	P1PS025DS7G0005
10	P1PS025DS7G0010
15	P1PS025DS7G0015
20	P1PS025DS7G0020
25	P1PS025DS7G0025
30	P1PS025DS7G0030
40	P1PS025DS7G0040
50	P1PS025DS7G0050
60	P1PS025DS7G0060

Ø32mm - (G1/8)

Stroke mm	Order code
5	P1PS032DS7G0005
10	P1PS032DS7G0010
15	P1PS032DS7G0015
20	P1PS032DS7G0020
25	P1PS032DS7G0025
30	P1PS032DS7G0030
40	P1PS032DS7G0040
50	P1PS032DS7G0050
60	P1PS032DS7G0060
80	P1PS032DS7G0080

Ø40mm - (G1/8)

Stroke mm	Order code
5	P1PS040DS7G0005
10	P1PS040DS7G0010
15	P1PS040DS7G0015
20	P1PS040DS7G0020
25	P1PS040DS7G0025
30	P1PS040DS7G0030
40	P1PS040DS7G0040
50	P1PS040DS7G0050
60	P1PS040DS7G0060
80	P1PS040DS7G0080

Ø50mm - (G1/8)

Stroke mm	Order code
5	P1PS050DS7G0005
10	P1PS050DS7G0010
15	P1PS050DS7G0015
20	P1PS050DS7G0020
25	P1PS050DS7G0025
30	P1PS050DS7G0030
40	P1PS050DS7G0040
50	P1PS050DS7G0050
60	P1PS050DS7G0060
80	P1PS050DS7G0080

Ø63mm - (G1/8)

Stroke mm	Order code
5	P1PS063DS7G0005
10	P1PS063DS7G0010
15	P1PS063DS7G0015
20	P1PS063DS7G0020
25	P1PS063DS7G0025
30	P1PS063DS7G0030
40	P1PS063DS7G0040
50	P1PS063DS7G0050
60	P1PS063DS7G0060
80	P1PS063DS7G0080

Ø80mm - (G1/8)

Stroke mm	Order code
5	P1PS080DS7G0005
10	P1PS080DS7G0010
15	P1PS080DS7G0015
20	P1PS080DS7G0020
25	P1PS080DS7G0025
30	P1PS080DS7G0030
40	P1PS080DS7G0040
50	P1PS080DS7G0050
60	P1PS080DS7G0060
80	P1PS080DS7G0080
100	P1PS080DS7G0100

Ø100mm - (G1/8)

Stroke mm	Order code
10	P1PS100DS7G0010
15	P1PS100DS7G0015
20	P1PS100DS7G0020
25	P1PS100DS7G0025
30	P1PS100DS7G0030
40	P1PS100DS7G0040
50	P1PS100DS7G0050
60	P1PS100DS7G0060
80	P1PS100DS7G0080
100	P1PS100DS7G0100

Sensors



For sensors see page 78.

Double acting - Guided

This cylinder version feature twin guide rods connected to the piston rod by a large flange plate. These cylinders are ideal for clamping an moving applications where turning of the piston rod must be avoided.



Double acting - Guided

Ø20mm - (M5)

Stroke mm	Order code
5	P1PG020DS7G0005
10	P1PG020DS7G0010
15	P1PG020DS7G0015
20	P1PG020DS7G0020
25	P1PG020DS7G0025
30	P1PG020DS7G0030
40	P1PG020DS7G0040
50	P1PG020DS7G0050
60	P1PG020DS7G0060

Ø25mm - (M5)

Stroke mm	Order code
5	P1PG025DS7G0005
10	P1PG025DS7G0010
15	P1PG025DS7G0015
20	P1PG025DS7G0020
25	P1PG025DS7G0025
30	P1PG025DS7G0030
40	P1PG025DS7G0040
50	P1PG025DS7G0050
60	P1PG025DS7G0060

Ø32mm - (G1/8)

Stroke mm	Order code
5	P1PG032DS7G0005
10	P1PG032DS7G0010
15	P1PG032DS7G0015
20	P1PG032DS7G0020
25	P1PG032DS7G0025
30	P1PG032DS7G0030
40	P1PG032DS7G0040
50	P1PG032DS7G0050
60	P1PG032DS7G0060
80	P1PG032DS7G0080

Ø40mm - (G1/8)

Stroke mm	Order code
5	P1PG040DS7G0005
10	P1PG040DS7G0010
15	P1PG040DS7G0015
20	P1PG040DS7G0020
25	P1PG040DS7G0025
30	P1PG040DS7G0030
40	P1PG040DS7G0040
50	P1PG040DS7G0050
60	P1PG040DS7G0060
80	P1PG040DS7G0080

Ø50mm - (G1/8)

Stroke mm	Order code
5	P1PG050DS7G0005
10	P1PG050DS7G0010
15	P1PG050DS7G0015
20	P1PG050DS7G0020
25	P1PG050DS7G0025
30	P1PG050DS7G0030
40	P1PG050DS7G0040
50	P1PG050DS7G0050
60	P1PG050DS7G0060
80	P1PG050DS7G0080

Ø63mm - (G1/8)

Stroke mm	Order code
5	P1PG063DS7G0005
10	P1PG063DS7G0010
15	P1PG063DS7G0015
20	P1PG063DS7G0020
25	P1PG063DS7G0025
30	P1PG063DS7G0030
40	P1PG063DS7G0040
50	P1PG063DS7G0050
60	P1PG063DS7G0060
80	P1PG063DS7G0080

Ø80mm - (G1/8)

Stroke mm	Order code
5	P1PG080DS7G0005
10	P1PG080DS7G0010
15	P1PG080DS7G0015
20	P1PS080DS7G0020
25	P1PG080DS7G0025
30	P1PG080DS7G0030
40	P1PG080DS7G0040
50	P1PG080DS7G0050
60	P1PG080DS7G0060
80	P1PG080DS7G0080
100	P1PG080DS7G0100

Ø100mm - (G1/8)

Stroke mm	Order code
10	P1PG100DS7G0010
15	P1PG100DS7G0015
20	P1PG100DS7G0020
25	P1PG100DS7G0025
30	P1PG100DS7G0030
40	P1PG100DS7G0040
50	P1PG100DS7G0050
60	P1PG100DS7G0060
80	P1PG100DS7G0080
100	P1PG100DS7G0100

Sensors



For sensors see page 78.

Single acting

Single acting P1P cylinders are available in bore sizes 20 - 63 mm and in two versions to suit a wide range of applications. Choose between the spring return (SS) and the spring extended (TS) versions.



Single acting - Spring return - Female threaded piston rod

Ø20mm - (M5)

Stroke mm	Order code
25	P1PS020SS7G0025

Ø25mm - (M5)

Stroke mm	Order code
25	P1PS025SS7G0025

Ø32mm - (G1/8)

Stroke mm	Order code
25	P1PS032SS7G0025

Ø40mm - (G1/8)

Stroke mm	Order code
25	P1PS040SS7G0025

Ø50mm - (G1/8)

Stroke mm	Order code
25	P1PS050SS7G0025

Ø63mm - (G1/8)

Stroke mm	Order code
25	P1PS063SS7G0025



Single acting - Spring extended - Female threaded piston rod

Ø20mm - (M5)

Stroke mm	Order code
25	P1PS020TS7G0025

Ø25mm - (M5)

Stroke mm	Order code
25	P1PS025TS7G0025

Ø32mm - (G1/8)

Stroke mm	Order code
25	P1PS032TS7G0025

Ø40mm - (G1/8)

Stroke mm	Order code
25	P1PS040TS7G0025

Ø50mm - (G1/8)

Stroke mm	Order code
25	P1PS050TS7G0025

Ø63mm - (G1/8)

Stroke mm	Order code
25	P1PS063TS7G0025

Note: Within limits other stroke lengths close to above standard stroke can be realised with corresponding change of the spring force.

Sensors



For sensors see page 78.

Double acting - Through piston rod

The P1P through rod cylinder version is available in bore sizes 20 - 100 mm. This cylinder type is used in many ways e.g. in applications with higher lateral forces or when performing a movement on both sides of the cylinder.



Double acting - Through piston rod - Female threaded piston rod

Ø20mm - (M5)

Stroke mm	Order code
5	P1PS020KS7G0005
10	P1PS020KS7G0010
15	P1PS020KS7G0015
20	P1PS020KS7G0020
25	P1PS020KS7G0025
30	P1PS020KS7G0030
40	P1PS020KS7G0040
50	P1PS020KS7G0050
60	P1PS020KS7G0060

Ø25mm - (M5)

Stroke mm	Order code
5	P1PS025KS7G0005
10	P1PS025KS7G0010
15	P1PS025KS7G0015
20	P1PS025KS7G0020
25	P1PS025KS7G0025
30	P1PS025KS7G0030
40	P1PS025KS7G0040
50	P1PS025KS7G0050
60	P1PS025KS7G0060

Ø32mm - (G1/8)

Stroke mm	Order code
5	P1PS032KS7G0005
10	P1PS032KS7G0010
15	P1PS032KS7G0015
20	P1PS032KS7G0020
25	P1PS032KS7G0025
30	P1PS032KS7G0030
40	P1PS032KS7G0040
50	P1PS032KS7G0050
60	P1PS032KS7G0060
80	P1PS032KS7G0080

Ø40mm - (G1/8)

Stroke mm	Order code
5	P1PS040KS7G0005
10	P1PS040KS7G0010
15	P1PS040KS7G0015
20	P1PS040KS7G0020
25	P1PS040KS7G0025
30	P1PS040KS7G0030
40	P1PS040KS7G0040
50	P1PS040KS7G0050
60	P1PS040KS7G0060
80	P1PS040KS7G0080

Ø50mm - (G1/8)

Stroke mm	Order code
5	P1PS050KS7G0005
10	P1PS050KS7G0010
15	P1PS050KS7G0015
20	P1PS050KS7G0020
25	P1PS050KS7G0025
30	P1PS050KS7G0030
40	P1PS050KS7G0040
50	P1PS050KS7G0050
60	P1PS050KS7G0060
80	P1PS050KS7G0080

Ø63mm - (G1/8)

Stroke mm	Order code
5	P1PS063KS7G0005
10	P1PS063KS7G0010
15	P1PS063KS7G0015
20	P1PS063KS7G0020
25	P1PS063KS7G0025
30	P1PS063KS7G0030
40	P1PS063KS7G0040
50	P1PS063KS7G0050
60	P1PS063KS7G0060
80	P1PS063KS7G0080

Ø80mm - (G1/8)

Stroke mm	Order code
5	P1PS080KS7G0005
10	P1PS080KS7G0010
15	P1PS080KS7G0015
20	P1PS080KS7G0020
25	P1PS080KS7G0025
30	P1PS080KS7G0030
40	P1PS080KS7G0040
50	P1PS080KS7G0050
60	P1PS080KS7G0060
80	P1PS080KS7G0080
100	P1PS080KS7G0100

Ø100mm - (G1/8)

Stroke mm	Order code
10	P1PS100KS7G0010
15	P1PS100KS7G0015
20	P1PS100KS7G0020
25	P1PS100KS7G0025
30	P1PS100KS7G0030
40	P1PS100KS7G0040
50	P1PS100KS7G0050
60	P1PS100KS7G0060
80	P1PS100KS7G0080
100	P1PS100KS7G0100

Sensors



For sensors see page 78.

Double acting - Low temperature

This P1P cylinder version is developed for use in temperatures down to -40°C. It is available in bore sizes 20 - 100 mm. With the combination of compactness and corrosion resistance the P1P low temperature version can be used in many industries e.g. Bus, Truck and Rail applications.



Double acting - Low temperature - Female threaded piston rod

Ø20mm - (M5)

Stroke mm	Order code
5	P1PS020DL7G0005
10	P1PS020DL7G0010
15	P1PS020DL7G0015
20	P1PS020DL7G0020
25	P1PS020DL7G0025
30	P1PS020DL7G0030
40	P1PS020DL7G0040
50	P1PS020DL7G0050
60	P1PS020DL7G0060

Ø25mm - (M5)

Stroke mm	Order code
5	P1PS025DL7G0005
10	P1PS025DL7G0010
15	P1PS025DL7G0015
20	P1PS025DL7G0020
25	P1PS025DL7G0025
30	P1PS025DL7G0030
40	P1PS025DL7G0040
50	P1PS025DL7G0050
60	P1PS025DL7G0060

Ø32mm - (G1/8)

Stroke mm	Order code
5	P1PS032DL7G0005
10	P1PS032DL7G0010
15	P1PS032DL7G0015
20	P1PS032DL7G0020
25	P1PS032DL7G0025
30	P1PS032DL7G0030
40	P1PS032DL7G0040
50	P1PS032DL7G0050
60	P1PS032DL7G0060
80	P1PS032DL7G0080

Ø40mm - (G1/8)

Stroke mm	Order code
5	P1PS040DL7G0005
10	P1PS040DL7G0010
15	P1PS040DL7G0015
20	P1PS040DL7G0020
25	P1PS040DL7G0025
30	P1PS040DL7G0030
40	P1PS040DL7G0040
50	P1PS040DL7G0050
60	P1PS040DL7G0040
80	P1PS040DL7G0050

Ø50mm - (G1/8)

Stroke mm	Order code
5	P1PS050DL7G0005
10	P1PS050DL7G0010
15	P1PS050DL7G0015
20	P1PS050DL7G0020
25	P1PS050DL7G0025
30	P1PS050DL7G0030
40	P1PS050DL7G0040
50	P1PS050DL7G0050
60	P1PS050DL7G0060
80	P1PS050DL7G0080

Ø63mm - (G1/8)

Stroke mm	Order code
5	P1PS063DL7G0005
10	P1PS063DL7G0010
15	P1PS063DL7G0015
20	P1PS063DL7G0020
25	P1PS063DL7G0025
30	P1PS063DL7G0030
40	P1PS063DL7G0040
50	P1PS063DL7G0050
60	P1PS063DL7G0060
80	P1PS063DL7G0080

Ø80mm - (G1/8)

Stroke mm	Order code
5	P1PS080DL7G0005
10	P1PS080DL7G0010
15	P1PS080DL7G0015
20	P1PS080DL7G0020
25	P1PS080DL7G0025
30	P1PS080DL7G0030
40	P1PS080DL7G0040
50	P1PS080DL7G0050
60	P1PS080DL7G0060
80	P1PS080DL7G0080
100	P1PS080DL7G0100

Ø100mm - (G1/8)

Stroke mm	Order code
10	P1PS100DL7G0010
15	P1PS100DL7G0015
20	P1PS100DL7G0020
25	P1PS100DL7G0025
30	P1PS100DL7G0030
40	P1PS100DL7G0040
50	P1PS100DL7G0050
60	P1PS100DL7G0060
80	P1PS100DL7G0080
100	P1PS100DL7G0100

Sensors



For sensors see page 78.

Double acting - High temperature

Use this P1P cylinder version, available in bore sizes 20 - 100 mm, for high temperature applications with temperatures up to +120°C. The chemical resistance thanks to the design in anodised aluminium is an advantage in many high temperature applications.



Double acting - High temperature - Female threaded piston rod

Ø20mm - (M5)

Stroke mm	Order code
5	P1PS020DF7G0005
10	P1PS020DF7G0010
15	P1PS020DF7G0015
20	P1PS020DF7G0020
25	P1PS020DF7G0025
30	P1PS020DF7G0030
40	P1PS020DF7G0040
50	P1PS020DF7G0050
60	P1PS020DF7G0060

Ø25mm - (M5)

Stroke mm	Order code
5	P1PS025DF7G0005
10	P1PS025DF7G0010
15	P1PS025DF7G0015
20	P1PS025DF7G0020
25	P1PS025DF7G0025
30	P1PS025DF7G0030
40	P1PS025DF7G0040
50	P1PS025DF7G0050
60	P1PS025DF7G0060

Ø32mm - (G1/8)

Stroke mm	Order code
5	P1PS032DF7G0005
10	P1PS032DF7G0010
15	P1PS032DF7G0015
20	P1PS032DF7G0020
25	P1PS032DF7G0025
30	P1PS032DF7G0030
40	P1PS032DF7G0040
50	P1PS032DF7G0050
60	P1PS032DF7G0060
80	P1PS032DF7G0080

Ø40mm - (G1/8)

Stroke mm	Order code
5	P1PS040DF7G0005
10	P1PS040DF7G0010
15	P1PS040DF7G0015
20	P1PS040DF7G0020
25	P1PS040DF7G0025
30	P1PS040DF7G0030
40	P1PS040DF7G0040
50	P1PS040DF7G0050
60	P1PS040DF7G0040
80	P1PS040DF7G0050

Ø50mm - (G1/8)

Stroke mm	Order code
5	P1PS050DF7G0005
10	P1PS050DF7G0010
15	P1PS050DF7G0015
20	P1PS050DF7G0020
25	P1PS050DF7G0025
30	P1PS050DF7G0030
40	P1PS050DF7G0040
50	P1PS050DF7G0050
60	P1PS050DF7G0060
80	P1PS050DF7G0080

Ø63mm - (G1/8)

Stroke mm	Order code
5	P1PS063DF7G0005
10	P1PS063DF7G0010
15	P1PS063DF7G0015
20	P1PS063DF7G0020
25	P1PS063DF7G0025
30	P1PS063DF7G0030
40	P1PS063DF7G0040
50	P1PS063DF7G0050
60	P1PS063DF7G0060
80	P1PS063DF7G0080

Ø80mm - (G1/8)

Stroke mm	Order code
5	P1PS080DF7G0005
10	P1PS080DF7G0010
15	P1PS080DF7G0015
20	P1PS080DF7G0020
25	P1PS080DF7G0025
30	P1PS080DF7G0030
40	P1PS080DF7G0040
50	P1PS080DF7G0050
60	P1PS080DF7G0060
80	P1PS080DF7G0080
100	P1PS080DF7G0100

Ø100mm - (G1/8)

Stroke mm	Order code
10	P1PS100DF7G0010
15	P1PS100DF7G0015
20	P1PS100DF7G0020
25	P1PS100DF7G0025
30	P1PS100DF7G0030
40	P1PS100DF7G0040
50	P1PS100DF7G0050
60	P1PS100DF7G0060
80	P1PS100DF7G0080
100	P1PS100DF7G0100

Dimensions - Bore 20 - 63mm

P1PS...DS7G Double acting with female piston rod thread

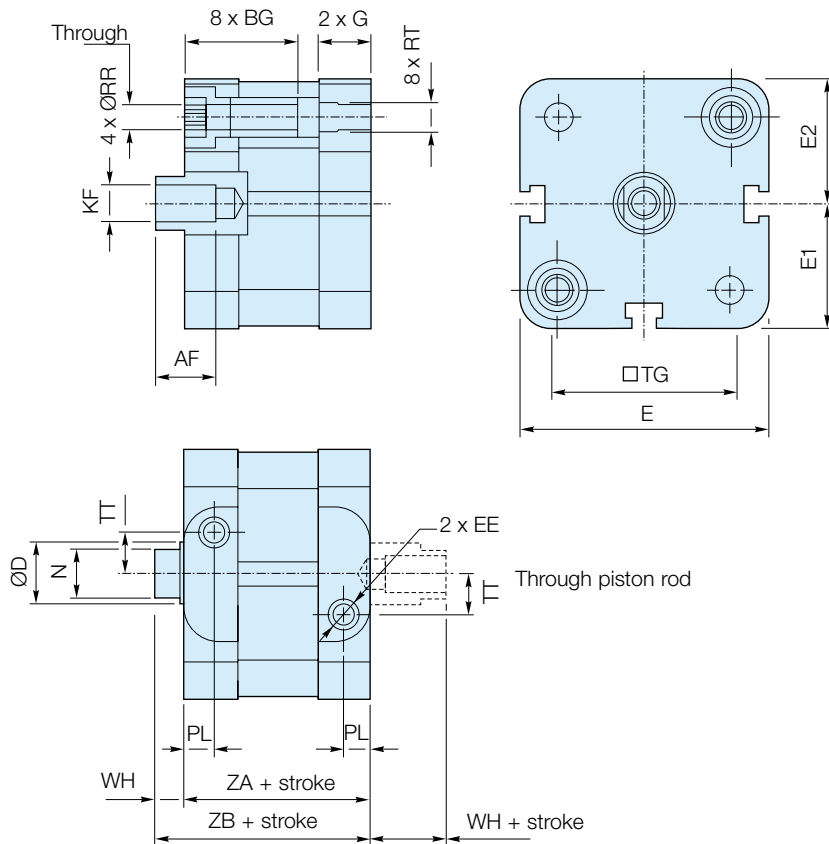

P1PG...DS Double acting with guided piston rod

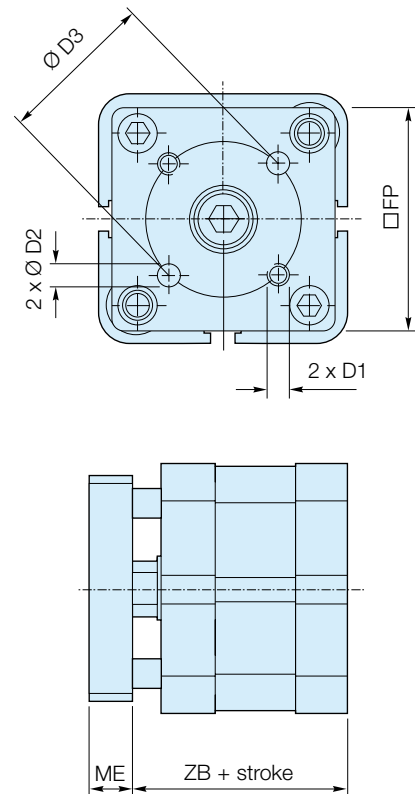

Bore size	AF min	BG min	ØD	D1	ØD2 H8	ØD3	EE	E	E1	E2	FP	G	KF	ME	N h14	PL	ØRR min	RT	TG	TT	WH	ZA ± 0,3	ZB ± 0,6
Ø20	10	15	10	M4	4	17	M5	38,0	19,0	19,1	35	11,60	M6	8	8	7,6	4,1	M5	22,0	4,0	6	37	43
Ø25	10	15	10	M5	5	22	M5	41,0	20,5	20,6	38	11,90	M6	8	8	7,5	4,1	M5	26,0	5,5	6	39	45
Ø32	12	16	12	M5	5	28	G1/8	49,4	24,7	24,9	45	15,25	M8	10	10	7,8	5,1	M6	32,5	6,5	7	44	51
Ø40	12	16	12	M5	5	33	G1/8	56,0	28,0	28,5	50	15,25	M8	10	10	8,0	5,1	M6	38,0	8,0	7	45	52
Ø50	16	16	16	M6	6	42	G1/8	67,0	33,5	33,7	60	14,30	M10	12	13	7,7	6,4	M8	46,5	11,0	8	45	53
Ø63	16	16	16	M6	6	50	G1/8	79,0	39,5	39,8	70	16,30	M10	12	13	8,0	6,4	M8	56,5	16,0	8	49	57

P1PS...DS8G Double acting with male piston rod thread

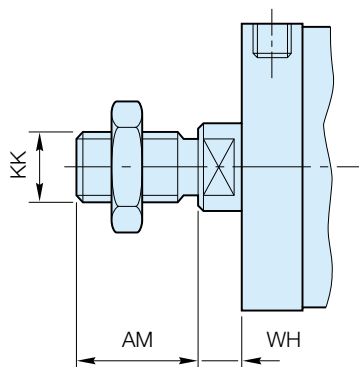

Bore size	AM +0 -0.5	WH		KK
		nom.	tol.	
Ø20	16	6	± 1,6	M8 x 1,25
Ø25	16	6	± 1,6	M8 x 1,25
Ø32	19	7	± 1,6	M10 x 1,25
Ø40	19	7	± 1,6	M10 x 1,25
Ø50	22	8	± 1,6	M12 x 1,25
Ø63	22	8	± 1,6	M12 x 1,25

Note: Cylinders with male piston rod thread are delivered with one piston rod nut in zinc plated steel

Dimensions - Bore 80 - 100mm

P1PS...DS7G Double acting with female piston rod thread

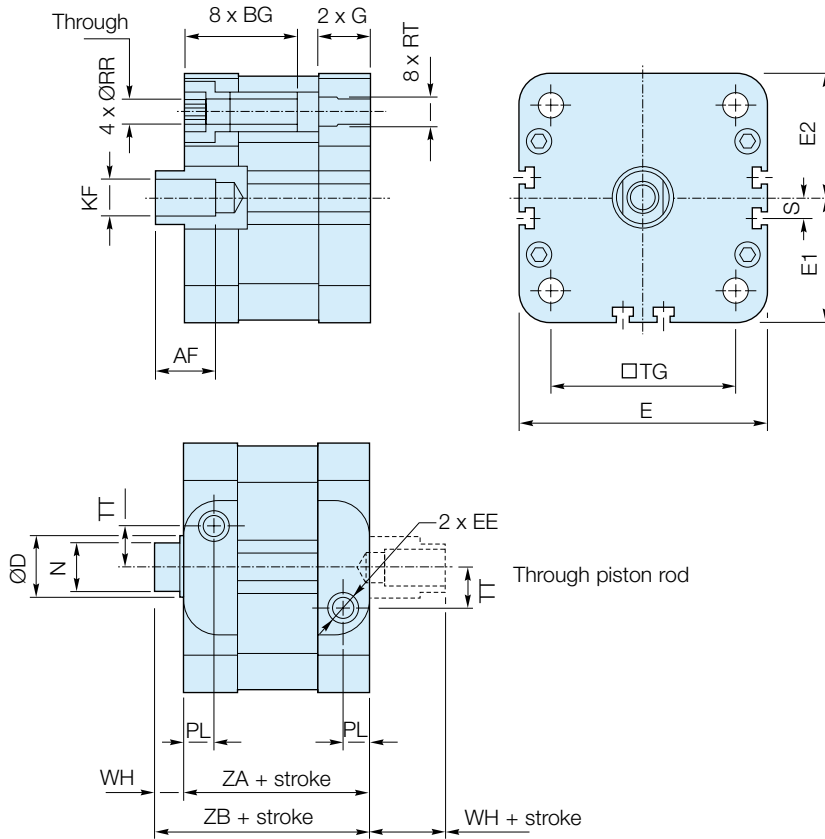

P1PG...DS Double acting with guided piston rod

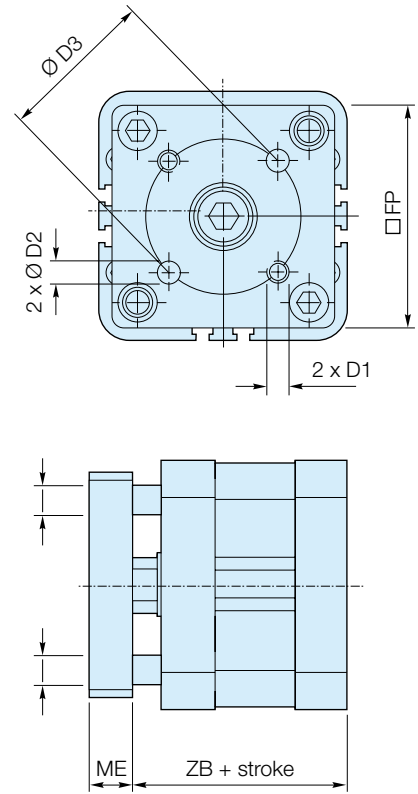

Bore size	AF	BG	ØD	D1	ØD2	ØD3	EE	E	E1	E2	FP	G	KF	ME	N	PL	ØRR	RT	S	TG	TT	WH	ZA	ZB
	min	min				H8									h14		min					± 0,3	± 0,6	
Ø80	20	17	20	M8	8	65	G1/8	96	48,0	48,2	90	17,7	M12	14	17	10,5	8,4	M10	8	72	20	10	54	64
Ø100	20	17	25	M10	10	80	G1/8	115	57,5	57,7	110	23,0	M12	14	21	12,0	8,4	M10	18,5	89	24	10	67	77

P1PS...DS8G Double acting with male piston rod thread

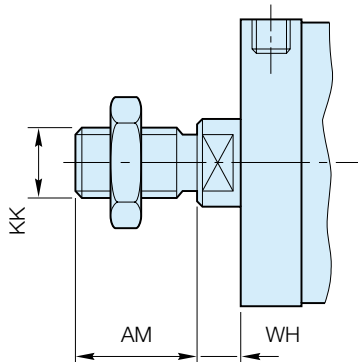

Bore size	AM	WH		KK
		nom.	tol.	
Ø80	28	10	± 1,6	M16 x 1,5
Ø100	28	10	± 1,6	M16 x 1,5

Note: Cylinders with male piston rod thread are delivered with one piston rod nut in zinc plated steel

	Flange MF1 / MF2 ¹	Foot brackets MS1 ²	Pivot bracket with rigid bearing AB7 ³	Clevis bracket MP2 ⁴	Clevis bracket MP4 ⁵
Ø 20	P1P-4HMB	P1P-4HMF			P1P-4HME
Ø 25	P1P-4JMB	P1P-4JMF			P1P-4JME
Ø 32	P1C-4KMB	P1C-4KMF	P1C-4KMD	P1C-4KMT	P1C-4KME
Ø 40	P1C-4LMB	P1C-4LMF	P1C-4LMD	P1C-4LMT	P1C-4LME
Ø 50	P1C-4MMB	P1C-4MMF	P1C-4MMD	P1C-4MMT	P1C-4MME
Ø 63	P1C-4NMB	P1C-4NMF	P1C-4NMD	P1C-4NMT	P1C-4NME
Ø 80	P1C-4PMB	P1C-4PMF	P1C-4PMD	P1C-4PMT	P1C-4PME
Ø 100	P1C-4QMB	P1C-4QMF	P1C-4QMD	P1C-4QMT	P1C-4QME
	Clevis bracket AB6 ⁶	Pivot bracket with swivel bearing AB5 ⁷	Swivel eye bracket MP6 ⁸	3 and 4 positions flange	Swivel rod eye AP6 ¹⁰
Ø 20					P1A-4HRS
Ø 25					P1A-4HRS
Ø 32	P1C-4KMCA	P1C-4KMA	P1C-4KMSA	P1E-6KB0	P1C-4KRS
Ø 40	P1C-4LMCA	P1C-4LMA	P1C-4LMSA	P1E-6LB0	P1C-4KRS
Ø 50	P1C-4MMCA	P1C-4MMA	P1C-4MMSA	P1E-6MB0	P1C-4LRS
Ø 63	P1C-4NMCA	P1C-4NMA	P1C-4NMSA	P1E-6NB0	P1C-4LRS
Ø 80	P1C-4PMCA	P1C-4PMA	P1C-4PMSA	P1E-6PB0	P1C-4MRS
Ø 100	P1C-4QMCA	P1C-4QMA	P1C-4QMSA	P1E-6QB0	P1C-4MRS
	Clevis AP2 ¹¹	Flexo coupling PM5 ¹²	Zinc-plated nut MR9 (Pack of 10 off)		
Ø 20	P1A-4HRC	P1C-4HRF	P14-4HRPZ		
Ø 25	P1A-4HRC	P1C-4HRF	P14-4HRPZ		
Ø 32	P1C-4KRC	P1C-4KRF	P14-4KRPZ		
Ø 40	P1C-4KRC	P1C-4KRF	P14-4KRPZ		
Ø 50	P1C-4LRC	P1C-4LRF	P14-4LRPZ		
Ø 63	P1C-4LRC	P1C-4LRF	P14-4LRPZ		
Ø 80	P1C-4MRC	P1C-4MRF	P14-4MRPZ		
Ø 100	P1C-4MRC	P1C-4MRF	P14-4MRPZ		

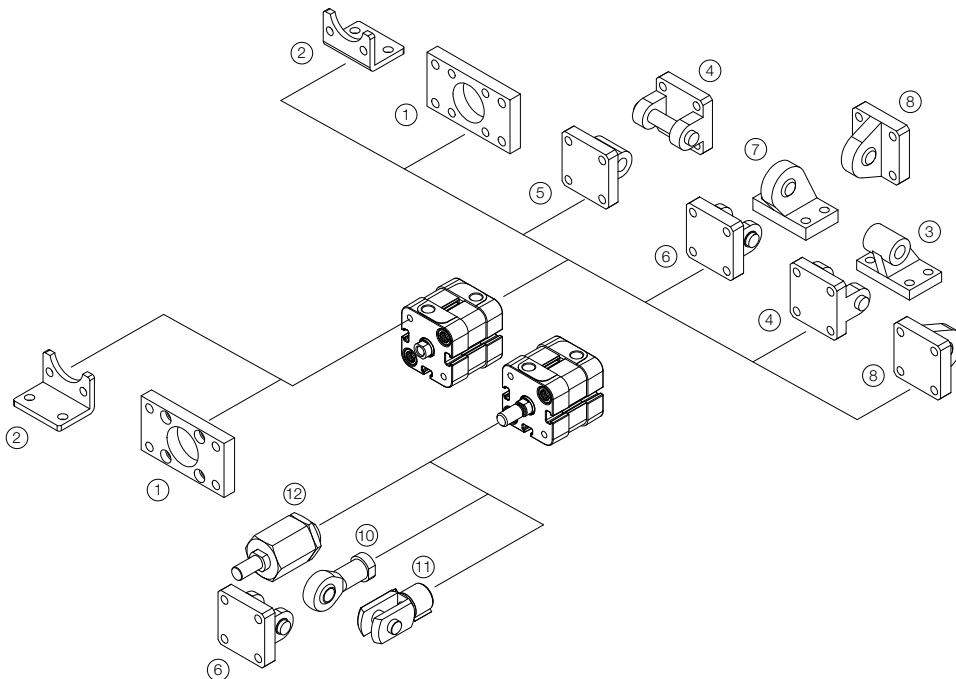

Cylinder mountings

Flange MF1/MF2



Intended for fixed mounting of cylinder. Flange can be fitted to front- or rear end-plates of cylinder.

Materials
 Flange: Surface-treated steel
 Mounting screws according to DIN 6912: Zinc-plated steel 8.8

Supplied complete with mounting screws for attachment to cylinder.

Ø32-100 according to ISO MF1/MF2, VDMA, AFNOR

Cyl. bore	d1	FB	TG1	E	R	MF	TF	UF	I1	W	ZF*	ZB*
mm	H11	H13			JS14	JS14	JS14		-0,5		mm	mm
mm	mm	mm	mm	mm	mm	mm	mm	mm	mm	mm	mm	mm
20	12,0	6,6	22,0	36	-	10,0	55,0	70	5,4	4,0	53,0	43,0
25	12,0	6,6	26,0	40	-	10,0	60,0	76	5,4	4,0	55,0	45,0
32	30,0	7,0	32,5	45	32	10,0	64,0	80	5,0	3,0	61,0	41,0
40	35,0	9,0	38,0	52	36	10,0	72,0	90	5,0	3,0	52,0	52,0
50	40,0	9,0	46,5	65	45	12,0	90,0	110	6,5	4,0	65,0	53,0
63	45,0	9,0	56,5	75	50	12,0	100,0	120	6,5	4,0	69,0	57,0
80	45,0	12,0	72,0	95	63	16,0	126,0	150	8,0	6,0	80,0	64,0
100	55,0	14,0	89,0	115	75	16,0	150,0	170	8,0	6,0	93,0	77,0

S = Stroke length

Cyl. bore Ø mm	Weight kg	Order code
20	0,17	P1P-4HMB
25	0,20	P1P-4JMB
32	0,23	P1C-4KMB
40	0,28	P1C-4LMB
50	0,53	P1C-4MMB
63	0,71	P1C-4NMB
80	1,59	P1C-4PMB
100	2,19	P1C-4QMB

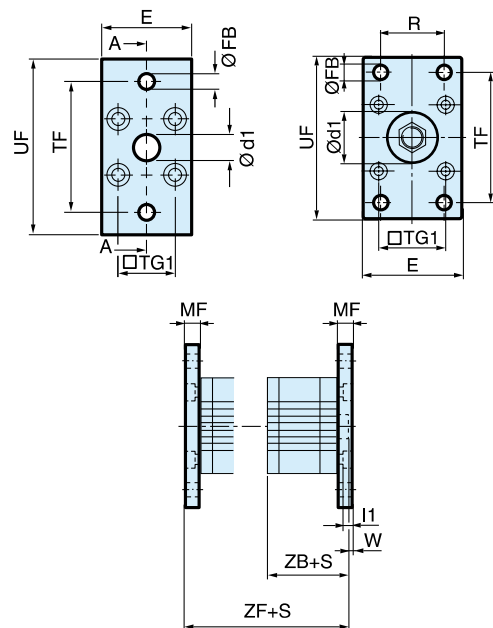

Foot brackets MS1



Intended for fixed mounting of cylinder. Angle bracket can be fitted to front- and rear end-plates of cylinder.

Materials
 Foot bracket: Surface-treated steel, black
 Mounting screws according to DIN 912: Zinc-plated steel 8.8

Supplied in pairs with mounting screws for attachment to cylinder.

Cyl. bore Ø mm	Weight kg	Order code
20	0,04**	P1P-4HMF
25	0,05**	P1P-4JMF
32	0,06**	P1C-4KMF
40	0,08**	P1C-4LMF
50	0,16**	P1C-4MMF
63	0,25**	P1C-4NMF*
80	0,50**	P1C-4PMF
100	0,85**	P1C-4QMF*

** Weight per item

Ø32-63 according to ISO MS1, VDMA, AFNOR

Cyl. bore	AB	TG1	E	TR	AO	AU	AH	I7	AT	I9	SA**
mm	H14			JS14			JS15			JS14	
mm	mm	mm	mm	mm	mm	mm	mm	mm	mm	mm	mm
20	6,6	22,0	36	26	6,0	16,0	27	22,0	4,0	17,0	69,0
25	6,6	26,0	40	26	6,0	16,0	30	23,0	4,0	19,0	71,0
32	7,0	32,5	45	32	10,0	24,0	32	30,0	4,5	17,5	92,0
40	9,0	38,0	52	36	8,0	28,0	36	30,0	4,5	18,5	101,0
50	9,0	46,5	65	45	13,0	32,0	45	36,0	5,5	25,0	109,0
63	9,0	56,5	75	50	13,0	32,0	50	35,0	5,5	27,5	113,0
80	12,0	72,0	95	63	14,0	41,0	63	49,0	6,5	40,5	136,0
100	14,0	89,0	115	75	15,0	41,0	71	54,0	6,5	43,5	149,0

S = Stroke length

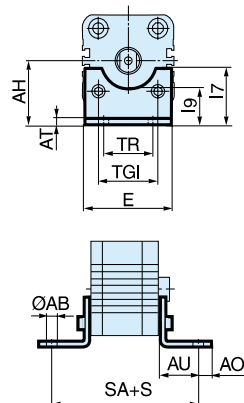

Cylinder mountings

Pivot bracket with rigid bearing AB7



Intended for flexible mounting of cylinder. The pivot bracket can be combined with clevis bracket MP2.

Materials
 Pivot bracket: Surface-treated aluminium, black
 Bearing: Sintered oil-bronze bushing

Cyl. bore Ø mm	Weight kg	Order code
32	0,06	P1C-4KMD
40	0,08	P1C-4LMD
50	0,15	P1C-4MMD
63	0,20	P1C-4NMD
80	0,33	P1C-4PMD
100	0,49	P1C-4QMD

According to CETOP RP 107 P, VDMA, AFNOR

Cyl. bore mm	CK H9 mm	S5 H13 mm	K1 JS14 mm	K2 mm	G1 JS14 mm	G2 JS14 mm	EM mm	G3 mm	CA JS15 mm	H6 mm	R1 mm
32	10	6,6	38	51	21	18	25,5	31	32	8	10
40	12	6,6	41	54	24	22	27,0	35	36	10	11
50	12	9,0	50	65	33	30	31,0	45	45	12	13
63	16	9,0	52	67	37	35	39,0	50	50	12	15
80	16	11,0	66	86	47	40	49,0	60	63	14	15
100	20	11,0	76	96	55	50	59,0	70	71	15	19

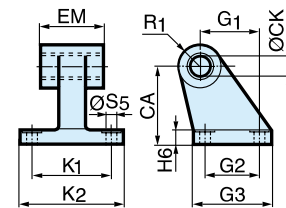

Clevis bracket MP2



Intended for flexible mounting of cylinder. Clevis bracket MP2 can be combined with clevis bracket MP4.

Materials
 Clevis bracket: Surface-treated aluminium, black
 Mounting screws according to DIN 912:
 Zinc-plated steel 8.8
 Pin: surface treated steel

Supplied complete with mounting screws for attachment to cylinder.

Cyl. bore Ø mm	Weight kg	Order code
32	0,08	P1C-4KMT
40	0,11	P1C-4LMT
50	0,14	P1C-4MMT
63	0,29	P1C-4NMT
80	0,36	P1C-4PMT
100	0,64	P1C-4QMT

According to ISO MP2, VDMA, AFNOR

Cyl. bore mm	E mm	UB h14 mm	CB H14 mm	FL ±0,2 mm	L mm	l2 mm	CD H9 mm	MR mm	XD* mm
32	45,0	45	26,0	22	13	5,5	10	10	73,0
40	52,0	52	28,0	25	16	5,5	12	12	77,0
50	65,0	60	32,0	27	16	6,5	12	12	80,0
63	75,0	70	40,0	32	21	6,5	16	16	89,0
80	95,0	90	50,0	36	22	10,0	16	16	100,0
100	115,0	110	60,0	41	27	10,0	20	20	118,0

S = Stroke length

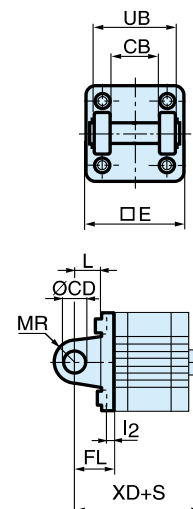

Cylinder mountings

Clevis bracket MP4



Intended for flexible mounting of cylinder. Clevis bracket MP4 can be combined with clevis bracket MP2.

Materials
 Clevis bracket: Surface-treated aluminium, black
 Mounting screws according to DIN 912: Zinc-plated steel 8.8

Supplied complete with mounting screws for attachment to cylinder.

Ø32-100 according to ISO MP4, VDMA, AFNOR

Cyl. bore mm	E mm	EW mm	FL mm	L mm	I2 mm	CD mm	MR mm	XD* mm
20	34,0	16,0	±0,2 20	14	2,6	8	8	63,0
25	38,0	16,0	20	14	2,6	8	8	65,0
32	45,0	26,0	22	13	5,5	10	10	73,0
40	52,0	28,0	25	16	5,5	12	12	77,0
50	65,0	32,0	27	16	6,5	12	12	80,0
63	75,0	40,0	32	21	6,5	16	16	89,0
80	95,0	50,0	36	22	10,0	16	16	100,0
100	115,0	60,0	41	27	10,0	20	20	118,0

S = Stroke length

Cyl. bore Ø mm	Weight kg	Order code
20	0,04	P1P-4HME
25	0,05	P1P-4JME
32	0,09	P1C-4KME
40	0,13	P1C-4LME
50	0,17	P1C-4MME
63	0,36	P1C-4NME
80	0,46	P1C-4PME
100	0,83	P1C-4QME

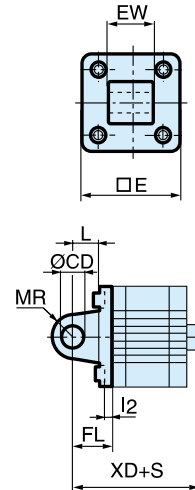

Clevis bracket AB6



Intended for flexible mounting of cylinder. Clevis bracket GA can be combined with pivot bracket with swivel bearing, swivel eye bracket and swivel rod eye.

Materials
 Clevis bracket: Surface-treated aluminium, black
 Pin: Surface hardened steel
 Locking pin: Spring steel
 Circlips according to DIN 471: Spring steel
 Mounting screws acc. to DIN 912: Zinc-plated steel 8.8

Supplied complete with mounting screws for attachment to cylinder.

According to VDMA, AFNOR

Cyl. bore mm	E mm	B2 mm	B1 mm	T mm	B3 mm	R2 mm	L1 mm	FL mm	I2 mm	L mm	CN mm	R1 mm	XD* mm
32	45	34	14	3	3,3	17	11,5	±0,2 22	5,5	12	10	11	73,0
40	52	40	16	4	4,3	20	12,0	25	5,5	15	12	13	77,0
50	65	45	21	4	4,3	22	14,0	27	6,5	17	16	18	80,0
63	75	51	21	4	4,3	25	14,0	32	6,5	20	16	18	89,0
80	95	65	25	4	4,3	30	16,0	36	10,0	20	20	22	100,0
100	115	75	25	4	4,3	32	16,0	41	10,0	25	20	22	118,0

S = Stroke length

Cyl. bore Ø mm	Weight kg	Order code
32	0,09	P1C-4KMCA
40	0,13	P1C-4LMCA
50	0,17	P1C-4MMCA
63	0,36	P1C-4NMCA
80	0,58	P1C-4PMCA
100	0,89	P1C-4QMCA

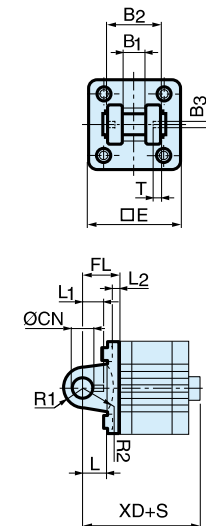

Stainless steel Pin Set AB6

Materials
 Pin: Stainless steel
 Locking pin: Stainless steel
 Circlips according to DIN 471: Stainless steel

Cyl. bore Ø mm	Weight kg	Order code
32	0,05	9301054311
40	0,06	9301054312
50	0,07	9301054313
63	0,07	9301054314
80	0,17	9301054315
100	0,31	9301054316

Cylinder mountings

Pivot bracket with swivel bearing AB5



Intended for use together with clevis bracket GA.

Material
 Pivot bracket: Surface-treated steel, black
 Swivel bearing according to DIN 648K: Hardened steel

Cyl. bore Ø mm	Weight kg	Order code
32	0,18	P1C-4KMA
40	0,25	P1C-4LMA
50	0,47	P1C-4MMA
63	0,57	P1C-4NMA
80	1,05	P1C-4PMA
100	1,42	P1C-4QMA

According to VDMA, AFNOR

Cyl. bore mm	CN H7 mm	S5 H13 mm	K1 JS14 mm	K2 mm	EU mm	G1 JS14 mm	G2 JS14 mm	EN mm	G3 mm	CH JS15 mm	H6 mm	ER mm	Z mm
32	10	6,6	38	51	10,5	21	18	14	31	32	10	16	4°
40	12	6,6	41	54	12,0	24	22	16	35	36	10	18	4°
50	16	9,0	50	65	15,0	33	30	21	45	45	12	21	4°
63	16	9,0	52	67	15,0	37	35	21	50	50	12	23	4°
80	20	11,0	66	86	18,0	47	40	25	60	63	14	28	4°
100	20	11,0	76	96	18,0	55	50	25	70	71	15	30	4°

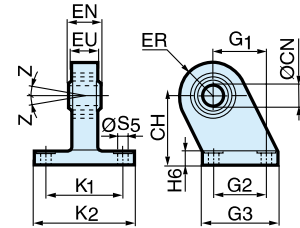

Swivel eye bracket MP6



Intended for use together with clevis bracket GA

Material
 Bracket: Surface-treated aluminium, black
 Swivel bearing acc. to DIN 648K: Hardened steel

Supplied complete with mounting screws for attachment to cylinder.

Cyl. bore Ø mm	Weight kg	Order code
32	0,08	P1C-4KMSA
40	0,11	P1C-4LMSA
50	0,20	P1C-4MMSA
63	0,27	P1C-4NMSA
80	0,52	P1C-4PMSA
100	0,72	P1C-4QMSA

According to VDMA, AFNOR

Cyl. bore mm	E mm	B1 mm	B2 mm	EN mm	R1 mm	R2 mm	FL mm	l2 mm	L mm	CN H7 mm	XD* mm	XD2* mm	Z mm
32	45	10,5	38	14	16	14	22	5,5	12	10	70,5	79,0	4°
40	52	12,0	44	16	18	16	25	5,5	15	12	75,5	83,5	4°
50	65	15,0	51	21	21	19	27	6,5	15	16	79,5	86,0	4°
63	75	15,0	56	21	23	22	32	6,5	20	16	90,0	95,5	4°
80	95	18,0	-	25	29	-	36	10,0	20	20	210,0	-	4°
100	115	18,0	-	25	31	-	41	10,0	25	20	230,0	-	4°

S=Stroke length

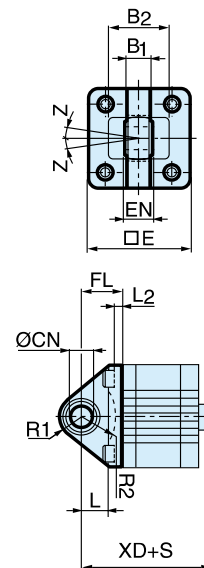

Cylinder mountings

3 and 4 positions flange



Mounting kit for back to back mounted cylinders, 3 and 4 position cylinders.

Material:
Mounting: Aluminium
Mounting screws: Zinc-plated steel 8.8

Cyl. bore Ø mm	Weight kg	Order code
32	0,060	P1E-6KB0
40	0,078	P1E-6LB0
50	0,162	P1E-6MB0
63	0,194	P1E-6NB0
80	0,450	P1E-6PB0
100	0,672	P1E-6QB0

Cyl. bore mm	E mm	TG mm	ØFB mm	MF mm	A mm	ØBA mm
32	50	32,5	6,5	5	16	30
40	60	38,0	6,5	5	16	35
50	66	46,5	8,5	6	20	40
63	80	56,5	8,5	6	20	45
80	100	72,0	10,5	8	25	45
100	118	89,0	10,5	8	25	55

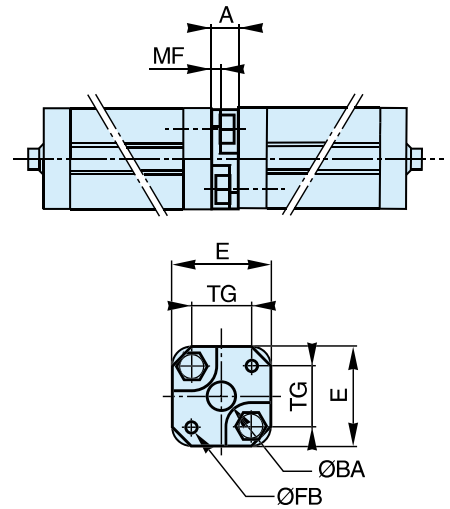

Piston rod mountings

Swivel rod eye AP6



Swivel rod eye for articulated mounting of cylinder. Swivel rod eye can be combined with clevis bracket GA. Maintenance-free.

Materials
Swivel rod eye: Zinc-plated steel
Swivel bearing according to DIN 648K: Hardened steel

Stainless steel swivel rod eye AP6



Stainless-steel swivel rod eye for articulated mounting of cylinder. Swivel rod eye can be combined with clevis bracket GA. Maintenance-free.

Materials
Swivel rod eye: Stainless steel
Swivel bearing according to DIN 648K: Stainless steel

Use stainless steel nut with stainless steel swivel rod eye.

Cyl. bore Ø mm	Weight kg	Order code
20 / 25	0,045	P1A-4HRS
32 / 40	0,08	P1C-4KRS
50 / 63	0,12	P1C-4LRS
80 / 100	0,25	P1C-4MRS

Cyl. bore Ø mm	Weight kg	Order code
20 / 25	0,045	P1S-4HRT
32 / 40	0,08	P1S-4JRT
50 / 63	0,12	P1S-4LRT
80 / 100	0,25	P1S-4MRT

According to ISO 8139

Cyl. bore mm	A mm	B min max mm	B max mm	CE mm	CN H9 mm	EN h12 mm	ER mm	KK mm	LE mm	N min mm	O mm	Z °
20 / 25	12	40,0	45	36	8	12	12	M8x1,25	12	13	9,0	12°
32 / 40	20	48,0	55	43	10	14	14	M10x1,25	15	17	10,5	12°
50 / 63	22	56,0	62	50	12	16	16	M12x1,25	17	19	12,0	12°
80 / 100	28	72,0	80	64	16	21	21	M16x1,5	22	22	15,0	15°

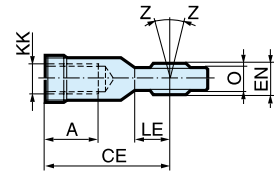
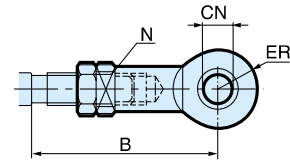

Clevis AP2



Clevis for articulated mounting of cylinder.

Material
Clevis, clip: Galvanized steel
Pin: Hardened steel

Cyl. bore Ø mm	Weight kg	Order code
20 / 25	0,045	P1A-4HRC
32 / 40	0,09	P1C-4KRC
50 / 63	0,15	P1C-4LRC
80 / 100	0,35	P1C-4MRC

Stainless steel clevis AP2



Stainless-steel clevis for articulated mounting of cylinder.

Material
Clevis: Stainless steel
Pin: Stainless steel
Circlips according to DIN 471: Stainless steel

Use stainless steel nut with stainless steel swivel rod eye.

Cyl. bore Ø mm	Weight kg	Order code
20 / 25	0,045	P1S-4HRD
32 / 40	0,09	P1S-4JRD
50 / 63	0,15	P1S-4LRD
80 / 100	0,35	P1S-4MRD

According to ISO 8140

Cyl. bore mm	A mm	B min max mm	B max mm	CE mm	CK h11/E9 mm	CL mm	CM mm	ER mm	KK mm	LE mm	O mm
20 / 25	16	36,0	41	32	8	16	8	-	M8x1,25	16	24,0
32 / 40	20	45,0	52	40	10	20	10	16	M10x1,25	20	28,0
50 / 63	24	54,0	60	48	12	24	12	19	M12x1,25	24	32,0
80 / 100	32	72,0	80	64	16	32	16	25	M16x1,5	32	41,5

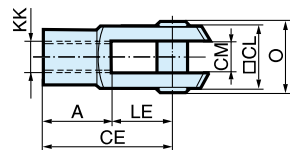
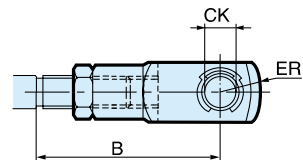

Piston rod mountings

Flexo coupling PM5

Flexo coupling for articulated mounting of piston rod. Flexo fitting is intended to take up axial angle errors within a range of $\pm 4^\circ$.

Material
Flexo coupling, nut: Zinc-plated steel

Supplied complete with galvanized adjustment nut.



Cyl. bore Ø mm	Weight kg	Order code
20 / 25	0,06	P1C-4JRF
32 / 40	0,23	P1C-4KRF
50 / 63	0,23	P1C-4LRF
80 / 100	0,65	P1C-4MRF

Cyl. bore mm	KK mm	B mm	C mm	D mm	E mm	ØF mm	SW1 mm	SW2 mm	SW3 mm	SW4 mm	SW5 mm
20 / 25	M8x1.25	16	14	55	20	12.4	7	17	17	10	13
32 / 40	M10x1.25	20	23	73	31	21	12	30	30	19	17
50 / 63	M12x1.5	24	23	77	31	21	12	30	30	19	19
80 / 100	M16x1.5	32	32	108	45	33.5	19	41	41	30	24

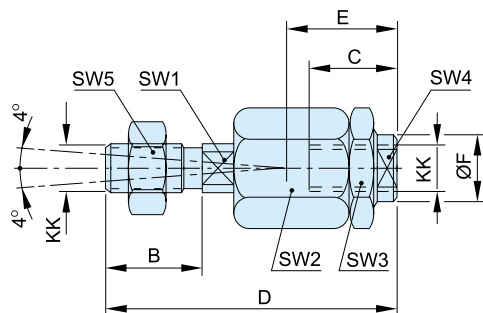

Nut MR9

Intended for fixed mounting of accessories to the piston rod. Material: Zinc-plated steel

All P1D cylinders are delivered with a zinc-plated steel piston rod nut.

Supplied as pack of 10 off



Cyl. bore Ø mm	Weight * kg	Order code
20 / 25	0,005	P14-4HRPZ
32 / 40	0,007	P14-4KRPZ
50 / 63	0,021	P14-4LRPZ
80 / 100	0,040	P14-4MRPZ

* Weight per item

Stainless steel nut

Intended for fixed mounting of accessories to the piston rod.

Material: Stainless steel A2

All P1D cylinders are delivered with a zinc-plated steel piston rod nut.

Supplied as pack of 10 off



Cyl. bore Ø mm	Weight * kg	Order code
20 / 25	0,005	P14-4HRPS
32 / 40	0,007	P14-4KRPS
50 / 63	0,021	P14-4LRPS
80 / 100	0,040	P14-4MRPS

* Weight per item

According to DIN 439 B

Cyl. bore mm	d	M	S
20 / 25	M8x1,25		
32 / 40	M10x1,25	5,0	17
50 / 63	M12x1,25	6,0	19
80 / 100	M16x1,5	10,0	30

